

PONTEIRAS DE ESCAPE

EXHAUST TRIMS
EMBOUTS D'ÉCHAPPEMENT

UNIVERSAL | UNIVERSAL FIT

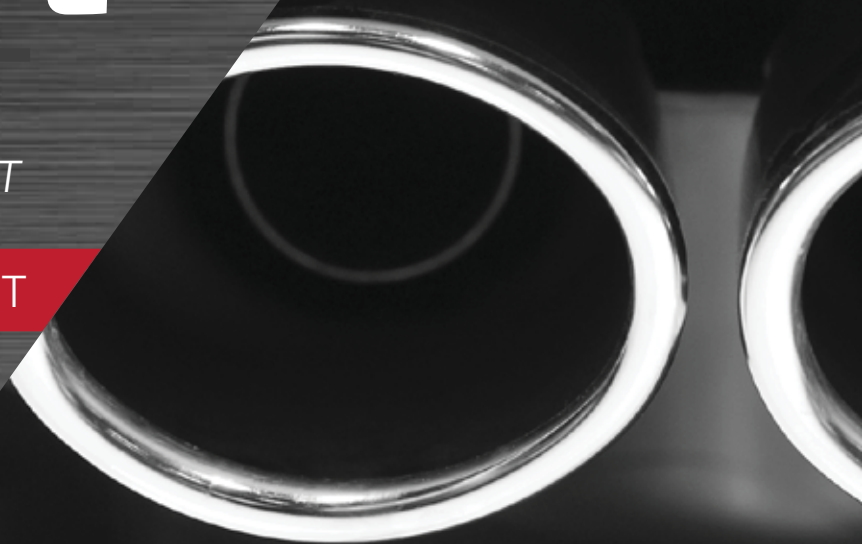

PAVILAUTO
AUTO PARTS & ACCESSORIES



PAVILAUTO
AUTO PARTS & ACCESSORIES

Rua do Casino, nº 95 Lt. 3
4765-063 Bairro
V.N. Famalicão · Portugal

Tlf. (+351) **252 907 210** · **252 981 420**
E-mail. **info@pavilauto.com**

www.pedroribeiroauto.com



ON THE ROAD

PONTEIRAS DE ESCAPE
EXHAUST TRIMS
EMBOUTS D'ÉCHAPPEMENT

PONTEIRA DUPLA
DOUBLE TRIM
D'ÉCHAPPEMENT DOUBLE

403

PAR
SET
PAIRE



Saída de escape
Exhaust exit
Sortie d'échappement



Sem miolo
Without silencer
Sans Intérieur



Solda
Welding
Soudure



Diâmetro máximo entrada
Maximum Fit size
Diamètre maximum d'entrée



DIREITA
RIGHT
DROIT



ESQUERDA
LEFT
GAUCHE

| Referência Reference Référence | Tipo Type Type | D. máx. entrada Max. Fit size D. max. d'entrée | Fixação Fixation Fixation | Miolo Silencer Intérieur | Material Material Matériel |
|--------------------------------------|---------------------------|--|---------------------------------|---|----------------------------------|
| 403.1-60 set | Dupla Double Double | 60mm | Solda Welding Soudure | Sem miolo Without silencer Sans intérieur | Inox |

Esquerda
Left
Gauche

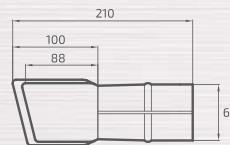
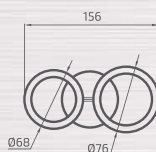

Par
Set
Paire

Direita
Right
Droit

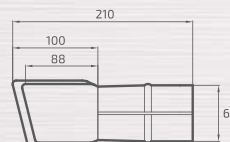
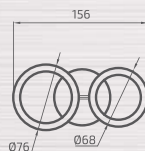

PONTEIRA DUPLA
DOUBLE TRIM
D'ÉCHAPPEMENT DOUBLE

PAR
SET
PAIRE

404



ESQUERDA
LEFT
GAUCHE



DIREITA
RIGHT
DROIT



Saída de escape
Exhaust exit
Sortie d'échappement



Sem miolo
Without silencer
Sans Intérieur



Solda
Welding
Soudure



Diâmetro máximo entrada
Maximum Fit size
Diamètre maximum d'entrée

| Referência Reference Référence | Tipo Type Type | D. máx. entrada Max. Fit size D. max. d'entrée | Fixação Fixation Fixation | Miolo Silencer Intérieur | Material Material Matériel |
|--------------------------------------|---------------------------|--|---------------------------------|---|----------------------------------|
| 404.1-60 set | Dupla Double Double | 60mm | Solda Welding Soudure | Sem miolo Without silencer Sans intérieur | Inox |

Par
Set
Paire

Direita
Right
Droit



Esquerda
Left
Gauche

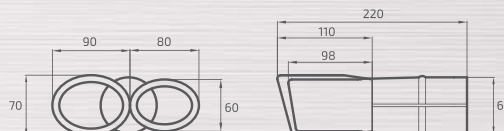

PONTEIRA REDONDA
ROUND TRIM
EMBOUT ROND

405



Saída de escape
Exhaust exit
Sortie d'échappement



Sem miolo
Without silencer
Sans Intérieur



Solda
Welding
Soudure



Diâmetro máximo entrada
Maximum Fit size
Diamètre maximum d'entrée



| Referência Reference Référence | Tipo Type Type | D. máx. entrada Max. Fit size D. max. d'entrée | Fixação Fixation Fixation | Miolo Silencer Intérieur | Material Material Matériel |
|--------------------------------------|--------------------------|--|---------------------------------|---|----------------------------------|
| 405.1-60 | Redonda Round Rond | 60mm | Solda Welding Soudure | Sem miolo Without silencer Sans intérieur | Inox |

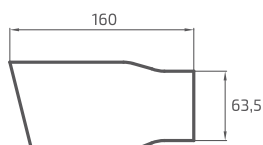
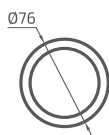

PONTEIRA REDONDA
ROUND TRIM
EMBOUT ROND

415



Saída de escape
Exhaust exit
Sortie d'échappement



Sem miolo
Without silencer
Sans Intérieur

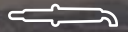

Solda
Welding
Soudure



Diâmetro máximo entrada
Maximum Fit size
Diamètre maximum d'entrée



| Referência Reference Référence | Tipo Type Type | D. máx. entrada Max. Fit size D. max. d'entrée | Fixação Fixation Fixation | Miolo Silencer Intérieur | Material Material Matériel |
|--------------------------------------|--------------------------|--|---------------------------------|---|----------------------------------|
| 415.1-60 | Redonda Round Rond | 60mm | Solda Welding Soudure | Sem miolo Without silencer Sans intérieur | Inox |

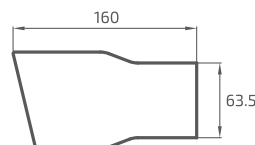
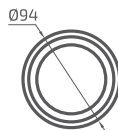

PONTEIRA DUPLA
DOUBLE TRIM
D'ÉCHAPPEMENT DOUBLE

423



Saída de escape
 Exhaust exit
 Sortie d'échappement



Com miolo
 With silencer
 Avec intérieur



Solda
 Welding
 Soudure



Diâmetro máximo entrada
 Maximum Fit size
 Diamètre maximum d'entrée



| Referência Reference Référence | Tipo Type Type | D. máx. entrada Max. Fit size D. max. d'entrée | Fixação Fixation Fixation | Miolo Silencer Intérieur | Material Material Matériel |
|--------------------------------------|---------------------------|--|---------------------------------|--|----------------------------------|
| 423B1-50 | Dupla Double Double | 50mm | Solda Welding Soudure | Com miolo With silencer Avec intérieur | Inox |

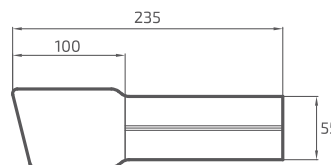
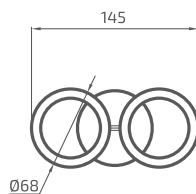

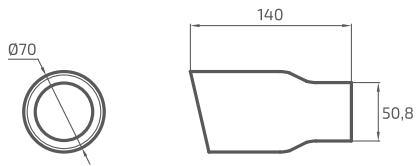

| Referência Reference Référence | Tipo Type Type | D. máx. entrada Max. Fit size D. max. d'entrée | Fixação Fixation Fixation | Miolo Silencer Intérieur | Material Material Matériel |
|--------------------------------------|--------------------------|--|---------------------------------|---|----------------------------------|
| 432.1-48 | Redonda Round Rond | 48mm | Solda Welding Soudure | Sem miolo Without silencer Sans intérieur | Inox |



Saída de escape
Exhaust exit
Sortie d'échappement



Sem miolo
Without silencer
Sans Intérieur



Solda
Welding
Soudure



Diâmetro máximo entrada
Maximum Fit size
Diamètre maximum d'entrée

432

PONTEIRA REDONDA
ROUND TRIM
EMBOU ROND

PONTEIRA DUPLA
DOUBLE TRIM
D'ÉCHAPPEMENT DOUBLE

433 PAR
SET
PAIRE



Saída de escape
Exhaust exit
Sortie d'échappement



Com miolo
With silencer
Avec intérieur



Solda
Welding
Soudure



Diâmetro máximo entrada
Maximum Fit size
Diamètre maximum d'entrée



DIREITA
RIGHT
DROIT



ESQUERDA
LEFT
GAUCHE

| Referência Reference Référence | Tipo Type Type | D. máx. entrada Max. Fit size D. max. d'entrée | Fixação Fixation Fixation | Miolo Silencer Intérieur | Material Material Matériel |
|--------------------------------------|---------------------------|--|---------------------------------|--|----------------------------------|
| 433B1-50 set | Dupla Double Double | 50mm | Solda Welding Soudure | Com miolo With silencer Avec intérieur | Inox |

Esquerda
Left
Gauche

Par
Set
Paire

Direita
Right
Droit

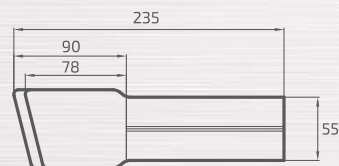
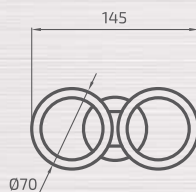

PONTEIRA REDONDA
ROUND TRIM
EMBOUT ROND

438



Saída de escape
Exhaust exit
Sortie d'échappement



Com miolo
With silencer
Avec intérieur



Solda
Welding
Soudure



Diâmetro máximo entrada
Maximum Fit size
Diamètre maximum d'entrée

| Referência Reference Référence | Tipo Type Type | D. máx. entrada Max. Fit size D. max. d'entrée | Fixação Fixation Fixation | Miolo Silencer Intérieur | Material Material Matériel |
|--------------------------------------|--------------------------|--|---------------------------------|--|----------------------------------|
| 438B1-60 | Redonda Round Rond | 60mm | Solda Welding Soudure | Com miolo With silencer Avec intérieur | Inox |

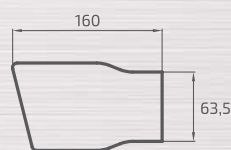

PONTEIRA RETANGULAR
RECTANGULAR TRIM
EMBOUT RECTANGULAIRE

442



Saída de escape
Exhaust exit
Sortie d'échappement



Sem miolo
Without silencer
Sans Intérieur

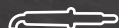

Solda
Welding
Soudure



Diâmetro máximo entrada
Maximum Fit size
Diamètre maximum d'entrée

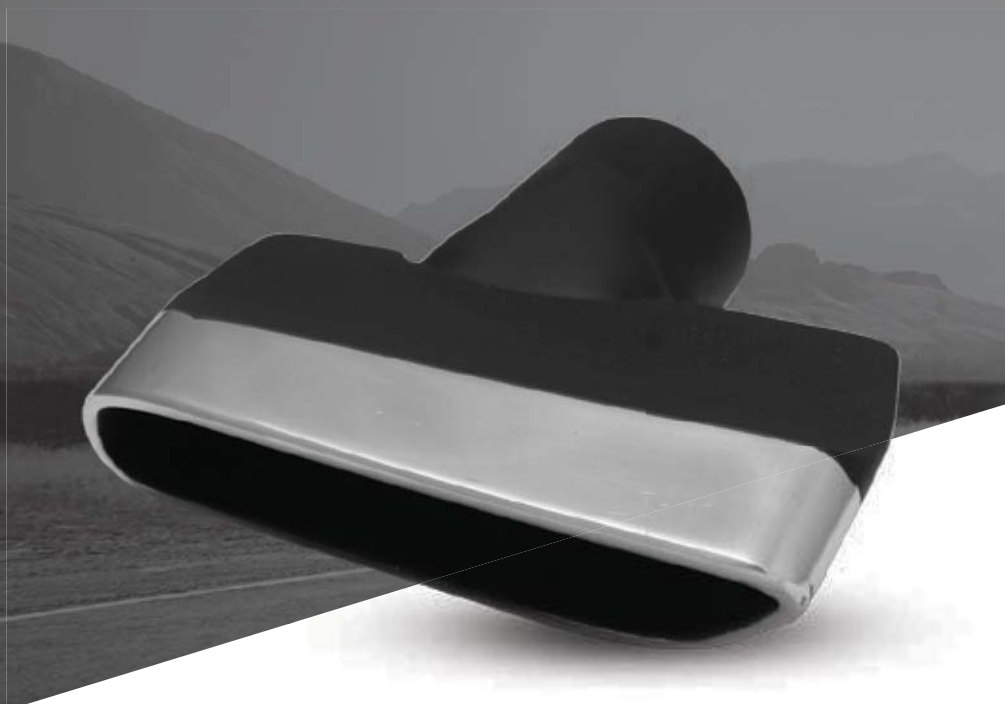

| Referência Reference Référence | Tipo Type Type | D. máx. entrada Max. Fit size D. max. d'entrée | Fixação Fixation Fixation | Miolo Silencer Intérieur | Material Material Matériel |
|--------------------------------------|--|--|---------------------------------|---|----------------------------------|
| 442.1 | Retangular Rectangular Rectangulaire | | Solda Welding Soudure | Sem miolo Without silencer Sans intérieur | Inox |

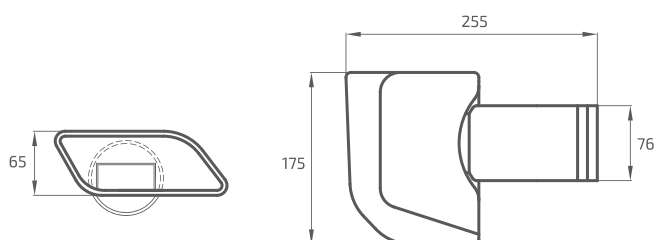

PONTEIRA REDONDA
ROUND TRIM
EMBOU T ROND

500



Saída de escape
Exhaust exit
Sortie d'échappement



Sem miolo
Without silencer
Sans Intérieur



Parafuso
Screw
Vis



Min.



Máx.

Diâmetro entrada
Fit size
Diamètre d'entrée



| Referência Reference Référence | Tipo Type Type | D. máx. entrada Max. Fit size D. max. d'entrée | Fixação Fixation Fixation | Miolo Silencer Intérieur | Material Material Matériel |
|--------------------------------------|--------------------------|--|---------------------------------|---|----------------------------------|
| 500.2-60 | Redonda Round Rond | 60mm | Parafuso Screw Vis | Sem miolo Without silencer Sans intérieur | Inox |

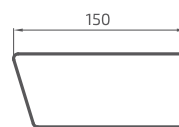

PONTEIRA REDONDA
 ROUND TRIM
 EMBOUT ROND

501



Saída de escape
 Exhaust exit
 Sortie d'échappement



Com miolo
 With silencer
 Avec intérieur



Sem miolo
 Without silencer
 Sans Intérieur

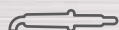

Solda
 Welding
 Soudure



Diâmetro máximo entrada
 Maximum Fit size
 Diamètre maximum d'entrée



| Referência Reference Référence | Tipo Type Type | D. máx. entrada Max. Fit size D. max. d'entrée | Fixação Fixation Fixation | Miolo Silencer Intérieur | Material Material Matériel |
|--------------------------------------|--------------------------|--|---------------------------------|---|----------------------------------|
| 501B1-48 | Redonda Round Rond | 48mm | Solda Welding Soudure | Com miolo With silencer Avec intérieur | Inox |
| 501.1-48 | Redonda Round Rond | 48mm | Solda Welding Soudure | Sem miolo Without silencer Sans intérieur | Inox |

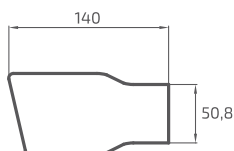
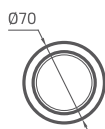

PONTEIRA DUPLA
DOUBLE TRIM
D'ÉCHAPPEMENT DOUBLE

502



Saída de escape
Exhaust exit
Sortie d'échappement



Com miolo
With silencer
Avec intérieur



Sem miolo
Without silencer
Sans intérieur



Solda
Welding
Soudure



Diâmetro máximo entrada
Maximum Fit size
Diamètre maximum d'entrée

| Referência Reference Référence | Tipo Type Type | D. máx. entrada Max. Fit size D. max. d'entrée | Fixação Fixation Fixation | Miolo Silencer Intérieur | Material Material Matériel |
|--------------------------------------|---------------------------|--|---------------------------------|---|----------------------------------|
| 502.1-50 | Dupla Double Double | 50mm | Solda Welding Soudure | Sem miolo Without silencer Sans intérieur | Inox |
| 502B1-50 | Dupla Double Double | 50mm | Solda Welding Soudure | Com miolo With silencer Avec intérieur | Inox |

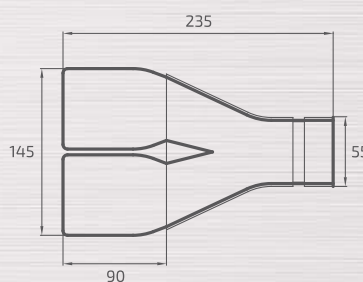
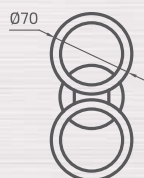

PONTEIRA REDONDA
ROUND TRIM
EMBOUT ROND

503



Saída de escape
 Exhaust exit
 Sortie d'échappement



Sem miolo
 Without silencer
 Sans Intérieur



Com miolo
 With silencer
 Avec intérieur



Miolo perfurado
 Perforated silencer
 Intérieur perforé



Solda
 Welding
 Soudure



Diâmetro máximo entrada
 Maximum Fit size
 Diamètre maximum d'entrée



| Referência Reference Référence | Tipo Type Type | D. máx. entrada Max. Fit size D. max. d'entrée | Fixação Fixation Fixation | Miolo Silencer Intérieur | Material Material Matériel |
|--------------------------------------|--------------------------|--|---------------------------------|---|----------------------------------|
| 503.1-48 | Redonda Round Rond | 48mm | Solda Welding Soudure | Sem miolo Without silencer Sans intérieur | Inox |
| 503A1-48 | Redonda Round Rond | 48mm | Solda Welding Soudure | Perfurado Perforated Perforé | Inox |
| 503B1-48 | Redonda Round Rond | 48mm | Solda Welding Soudure | Com miolo With silencer Avec intérieur | Inox |

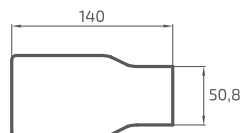
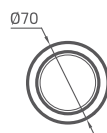

PONTEIRA REDONDA
ROUND TRIM
EMBOUT ROND

504



Saída de escape
Exhaust exit
Sortie d'échappement



Com miolo
With silencer
Avec intérieur

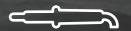

Solda
Welding
Soudure



Diâmetro máximo entrada
Maximum Fit size
Diamètre maximum d'entrée



| Referência Reference Référence | Tipo Type Type | D. máx. entrada Max. Fit size D. max. d'entrée | Fixação Fixation Fixation | Miolo Silencer Intérieur | Material Material Matériel |
|--------------------------------------|--------------------------|--|---------------------------------|--|----------------------------------|
| 504B1-60 | Redonda Round Rond | 60mm | Solda Welding Soudure | Com miolo With silencer Avec intérieur | Inox |

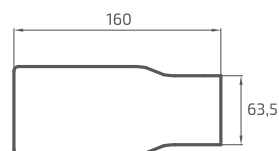
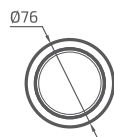

PONTEIRA REDONDA
ROUND TRIM
EMBOUIT ROND

505



Saída de escape
Exhaust exit
Sortie d'échappement



Com miolo
With silencer
Avec intérieur

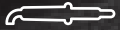

Solda
Welding
Soudure



Diâmetro máximo entrada
Maximum Fit size
Diamètre maximum d'entrée



| Referência Reference Référence | Tipo Type Type | D. máx. entrada Max. Fit size D. max. d'entrée | Fixação Fixation Fixation | Miolo Silencer Intérieur | Material Material Matériel |
|--------------------------------------|--------------------------|--|---------------------------------|--|----------------------------------|
| 505B1-60 | Redonda Round Rond | 60mm | Solda Welding Soudure | Com miolo With silencer Avec intérieur | Inox |

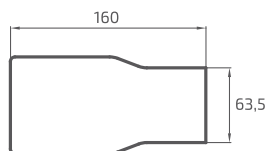
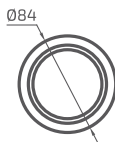

PONTEIRA REDONDA
 ROUND TRIM
 EMBOUT ROND

506



Saída de escape
 Exhaust exit
 Sortie d'échappement



Miolo perfurado
 Perforated silencer
 Intérieur perforé



Com miolo
 With silencer
 Avec intérieur



Solda
 Welding
 Soudure



Diâmetro máximo entrada
 Maximum Fit size
 Diamètre maximum d'entrée



| Referência Reference Référence | Tipo Type Type | D. máx. entrada Max. Fit size D. max. d'entrée | Fixação Fixation Fixation | Miolo Silencer Intérieur | Material Material Matériel |
|--------------------------------------|--------------------------|--|---------------------------------|--|----------------------------------|
| 506A1-60 | Redonda Round Rond | 60mm | Solda Welding Soudure | Perfurado Perforated Perforé | Inox |
| 506B1-60 | Redonda Round Rond | 60mm | Solda Welding Soudure | Com miolo With silencer Avec intérieur | Inox |

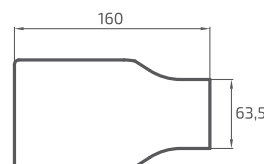
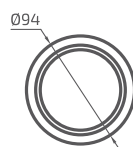

PONTEIRA OVAL
 OVAL TRIM
 EMBOUT OVALE

507



Saída de escape
 Exhaust exit
 Sortie d'échappement



Sem miolo
 Without silencer
 Sans Intérieur



Com miolo
 With silencer
 Avec intérieur



Solda
 Welding
 Soudure



Diâmetro máximo entrada
 Maximum Fit size
 Diamètre maximum d'entrée



| Referência Reference Référence | Tipo Type Type | D. máx. entrada Max. Fit size D. max. d'entrée | Fixação Fixation Fixation | Miolo Silencer Intérieur | Material Material Matériel |
|--------------------------------------|--------------------------|--|---------------------------------|---|----------------------------------|
| 5071-60 | Redonda Round Rond | 60mm | Solda Welding Soudure | Sem miolo Without silencer Sans intérieur | Inox |
| 507B1-60 | Redonda Round Rond | 60mm | Solda Welding Soudure | Com miolo With silencer Avec intérieur | Inox |

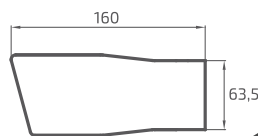
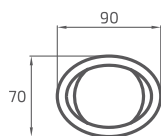

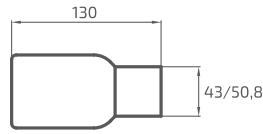
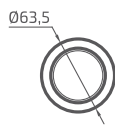

| Referência Reference Référence | Tipo Type Type | D. máx. entrada Max. Fit size D. max. d'entrée | Fixação Fixation Fixation | Miolo Silencer Intérieur | Material Material Matériel |
|--------------------------------------|--------------------------|--|---------------------------------|--|----------------------------------|
| 510B1-40 | Redonda Round Rond | 40mm | Solda Welding Soudure | Com miolo With silencer Avec intérieur | Inox |
| 510B1-48 | Redonda Round Rond | 48mm | Solda Welding Soudure | Com miolo With silencer Avec intérieur | Inox |



Saída de escape
Exhaust exit
Sortie d'échappement



Com miolo
With silencer
Avec intérieur



Solda
Welding
Soudure



Diâmetro máximo entrada
Maximum Fit size
Diamètre maximum d'entrée

510

PONTEIRA REDONDA
ROUND TRIM
EMBOUT ROND

PONTEIRA OVAL
 OVAL TRIM
 EMBOUT OVALE

512

PAR
 SET
 PAIRE



Saída de escape
 Exhaust exit
 Sortie d'échappement



Com miolo
 With silencer
 Avec intérieur

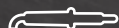

Solda
 Welding
 Soudure



Diâmetro máximo entrada
 Maximum Fit size
 Diamètre maximum d'entrée



ESQUERDA
 LEFT
 GAUCHE



DIREITA
 RIGHT
 DROIT

| Referência Reference Référence | Tipo Type Type | D. máx. entrada Max. Fit size D. max. d'entrée | Fixação Fixation Fixation | Miolo Silencer Intérieur | Material Material Matériel |
|--------------------------------------|-----------------------|--|---------------------------------|--|----------------------------------|
| 512B1-60 | Oval Oval Ovale | 60mm | Solda Welding Soudure | Com miolo With silencer Avec intérieur | Inox |

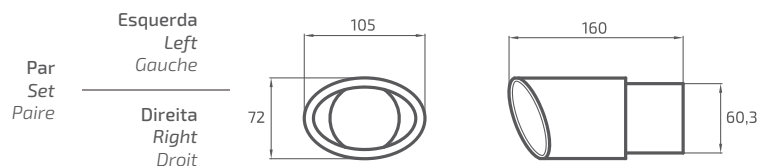

PONTEIRA OVAL
OVAL TIP
EXTRÉMITÉ OVALE

513



Saída de escape
Exhaust exit
Sortie d'échappement



Com miolo
With silencer
Avec intérieur



Sem miolo
Without silencer
Sans Intérieur



Solda
Welding
Soudure



Diâmetro máximo entrada
Maximum Fit size
Diamètre maximum d'entrée



| Referência Reference Référence | Tipo Type Type | D. máx. entrada Max. Fit size D. max. d'entrée | Fixação Fixation Fixation | Miolo Silencer Intérieur | Material Material Matériel |
|--------------------------------------|-----------------------|--|---------------------------------|---|----------------------------------|
| 513.1-48 | Oval Oval Ovale | 48mm | Solda Welding Soudure | Sem miolo Without silencer Sans intérieur | Inox |
| 513B1-48 | Oval Oval Ovale | 48mm | Solda Welding Soudure | Com miolo With silencer Avec intérieur | Inox |

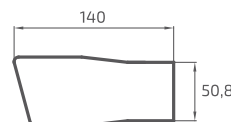
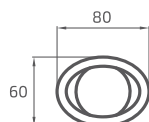

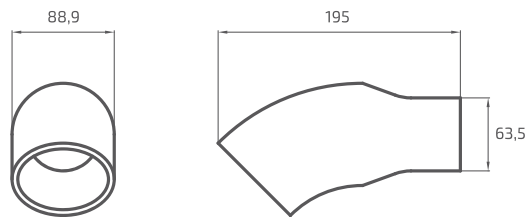

| Referência Reference Référence | Tipo Type Type | D. máx. entrada Max. Fit size D. max. d'entrée | Fixação Fixation Fixation | Miolo Silencer Intérieur | Material Material Matériel |
|--------------------------------------|----------------------|--|---------------------------------|---|----------------------------------|
| 516.1-60 | Diesel | 60mm | Solda Welding Soudure | Sem miolo Without silencer Sans intérieur | Inox |



Saída de escape
Exhaust exit
Sortie d'échappement



Sem miolo
Without silencer
Sans intérieur



Solda
Welding
Soudure



Diâmetro máximo entrada
Maximum Fit size
Diamètre maximum d'entrée



516

PONTEIRA DIESEL
DIESEL TRIM
EMBOU D'ÉCHAPPEMENT DIESEL

PONTEIRA RETANGULAR
RECTANGULAR TRIM
EMBOUT RECTANGULAIRE

519



Saída de escape
Exhaust exit
Sortie d'échappement



Miolo perfurado
Perforated silencer
Intérieur perforé



Solda
Welding
Soudure



Diâmetro máximo entrada
Maximum Fit size
Diamètre maximum d'entrée

| Referência Reference Référence | Tipo Type Type | D. máx. entrada Max. Fit size D. max. d'entrée | Fixação Fixation Fixation | Miolo Silencer Intérieur | Material Material Matériel |
|--------------------------------------|--|--|---------------------------------|------------------------------------|----------------------------------|
| 519A1-60 | Retangular Rectangular Rectangulaire | 60mm | Solda Welding Soudure | Perfurado Perforated Perforé | Inox |

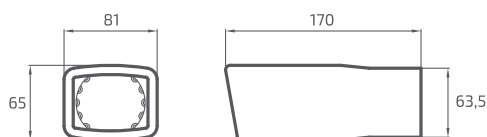

PONTEIRA RETANGULAR
RECTANGULAR TRIM
EMBOUIT RECTANGULAIRE

520



Saída de escape
Exhaust exit
Sortie d'échappement



Miolo perfurado
Perforated silencer
Intérieur perforé

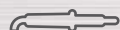

Solda
Welding
Soudure



Diâmetro máximo entrada
Maximum fit size
Diamètre maximum d'entrée



| Referência Reference Référence | Tipo Type Type | D. máx. entrada Max. fit size D. max. d'entrée | Fixação Fixation Fixation | Miolo Silencer Intérieur | Material Material Matériel |
|--------------------------------------|--|--|---------------------------------|------------------------------------|----------------------------------|
| 520A1-60 | Retangular Rectangular Rectangulaire | 60mm | Solda Welding Soudure | Perfurado Perforated Perforé | Inox |

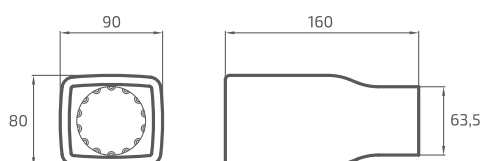

PONTEIRA RETANGULAR
RECTANGULAR TIP
EMBOUIT RECTANGULAIRE

521



Saída de escape
Exhaust exit
Sortie d'échappement



Miolo perfurado
Perforated silencer
Intérieur perforé



Solda
Welding
Soudure



Diâmetro máximo entrada
Maximum fit size
Diamètre maximum d'entrée



| Referência Reference Référence | Tipo Type Type | D. máx. entrada Max. Fit size D. max. d'entrée | Fixação Fixation Fixation | Miolo Silencer Intérieur | Material Material Matériel |
|--------------------------------------|--|--|---------------------------------|------------------------------------|----------------------------------|
| 521A1-60 | Retangular Rectangular Rectangulaire | 60mm | Solda Welding Soudure | Perfurado Perforated Perforé | Inox |

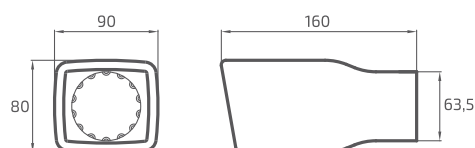

PONTEIRA RETANGULAR
RECTANGULAR TIP
EMBOUT RECTANGULAIRE

522



Saída de escape
Exhaust exit
Sortie d'échappement



Com miolo
With silencer
Avec intérieur



Solda
Welding
Soudure



Diâmetro máximo entrada
Maximum Fit size
Diamètre maximum d'entrée



| Referência Reference Référence | Tipo Type Type | D. máx. entrada Max. Fit size D. max. d'entrée | Fixação Fixation Fixation | Miolo Silencer Intérieur | Material Material Matériel |
|--------------------------------------|--|--|---------------------------------|--|----------------------------------|
| 522B1-57 | Retangular Rectangular Rectangulaire | 57mm | Solda Welding Soudure | Com miolo With silencer Avec intérieur | Inox |

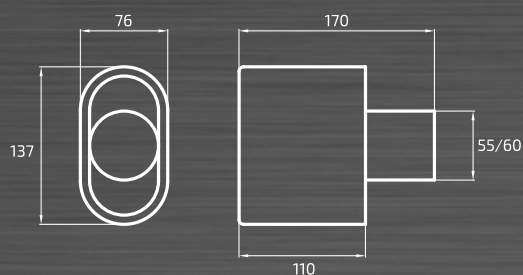

PONTEIRA DTM
DTM TRIM
EMBOU DTM

523



Saída de escape
Exhaust exit
Sortie d'échappement



Com miolo
With silencer
Avec intérieur



Solda
Welding
Soudure



Diâmetro máximo entrada
Maximum Fit size
Diamètre maximum d'entrée



| Referência Reference Référence | Tipo Type Type | D. máx. entrada Max. Fit size D. max. d'entrée | Fixação Fixation Fixation | Miolo Silencer Intérieur | Material Material Matériel |
|--------------------------------------|----------------------|--|---------------------------------|--|----------------------------------|
| 523B1-77 | DTM | 77mm | Solda Welding Soudure | Com miolo With silencer Avec intérieur | Inox |

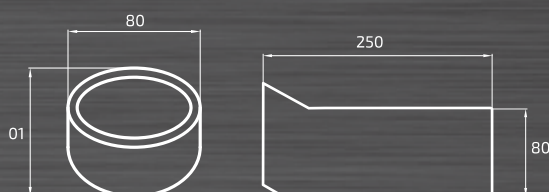

PONTEIRA REDONDA
ROUND TRIM
EMBOUT ROND

524



Saída de escape
Exhaust exit
Sortie d'échappement



Com miolo
With silencer
Avec intérieur



Solda
Welding
Soudure



Diâmetro máximo entrada
Maximum Fit size
Diamètre maximum d'entrée



| Referência Reference Référence | Tipo Type Type | D. máx. entrada Max. Fit size D. max. d'entrée | Fixação Fixation Fixation | Miolo Silencer Intérieur | Material Material Matériel |
|--------------------------------------|--------------------------|--|---------------------------------|--|----------------------------------|
| 524B1-73 | Redonda Round Rond | 73mm | Solda Welding Soudure | Com miolo With silencer Avec intérieur | Inox |

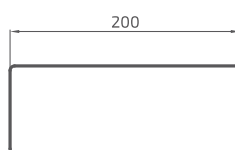
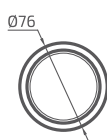

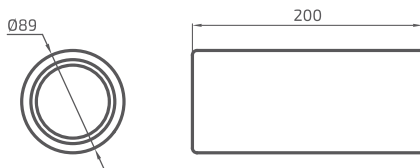

| Referência Reference Référence | Tipo Type Type | D. máx. entrada Max. Fit size D. max. d'entrée | Fixação Fixation Fixation | Miolo Silencer Intérieur | Material Material Matériel |
|--------------------------------------|--------------------------|--|---------------------------------|--|----------------------------------|
| 526B1-85 | Redonda Round Rond | 85mm | Solda Welding Soudure | Com miolo With silencer Avec intérieur | Inox |



Saída de escape
Exhaust exit
Sortie d'échappement



Com miolo
With silencer
Avec intérieur



Solda
Welding
Soudure



Diâmetro máximo entrada
Maximum Fit size
Diamètre maximum d'entrée

526

PONTEIRA REDONDA
ROUND TRIM
EMBOU ROND

PONTEIRA OVAL
OVAL TIP
EXTRÉMITÉ OVALE

528



Saída de escape
Exhaust exit
Sortie d'échappement



Com miolo
With silencer
Avec intérieur



Solda
Welding
Soudure



Diâmetro máximo entrada
Maximum Fit size
Diamètre maximum d'entrée



| Referência Reference Référence | Tipo Type Type | D. máx. entrada Max. Fit size D. max. d'entrée | Fixação Fixation Fixation | Miolo Silencer Intérieur | Material Material Matériel |
|--------------------------------------|-----------------------|--|---------------------------------|--|----------------------------------|
| 528B1-52 | Oval Oval Ovale | 52mm | Solda Welding Soudure | Com miolo With silencer Avec intérieur | Inox |

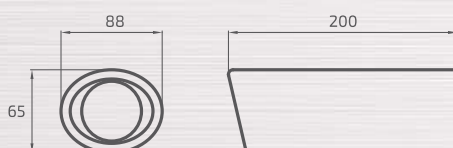

PONTEIRA RETANGULAR
RECTANGULAR TRIM
EMBOUT RECTANGULAIRE

530



Saída de escape
Exhaust exit
Sortie d'échappement



Com miolo
With silencer
Avec intérieur



Solda
Welding
Soudure



Diâmetro máximo entrada
Maximum Fit size
Diamètre maximum d'entrée

| Referência Reference Référence | Tipo Type Type | D. máx. entrada Max. Fit size D. max. d'entrée | Fixação Fixation Fixation | Miolo Silencer Intérieur | Material Material Matériel |
|--------------------------------------|--|--|---------------------------------|--|----------------------------------|
| 530B1-52 | Retangular Rectangular Rectangulaire | 52mm | Solda Welding Soudure | Com miolo With silencer Avec intérieur | Inox |



PONTEIRA OVAL
 OVAL TRIM
 EMBOUT OVALE

531



Saída de escape
 Exhaust exit
 Sortie d'échappement



Sem miolo
 Without silencer
 Sans Intérieur



Com miolo
 With silencer
 Avec intérieur



Solda
 Welding
 Soudure



Diâmetro máximo entrada
 Maximum Fit size
 Diamètre maximum d'entrée



| Referência Reference Référence | Tipo Type Type | D. máx. entrada Max. Fit size D. max. d'entrée | Fixação Fixation Fixation | Miolo Silencer Intérieur | Material Material Matériel |
|--------------------------------------|--|--|---------------------------------|---|----------------------------------|
| 531.1 | Retangular Rectangular Rectangulaire | 70mm | Solda Welding Soudure | Sem miolo Without silencer Sans intérieur | Inox |
| 531B1-57 | Retangular Rectangular Rectangulaire | 57mm | Solda Welding Soudure | Com miolo With silencer Avec intérieur | Inox |

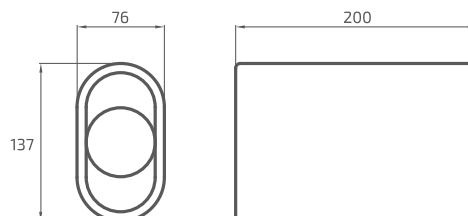

PONTEIRA RETANGULAR
RECTANGULAR TRIM
EMBOUT RECTANGULAIRE

532



Saída de escape
Exhaust exit
Sortie d'échappement



Com miolo
With silencer
Avec intérieur



Sem miolo
Without silencer
Sans Intérieur



Solda
Welding
Soudure



Diâmetro máximo entrada
Maximum Fit size
Diamètre maximum d'entrée

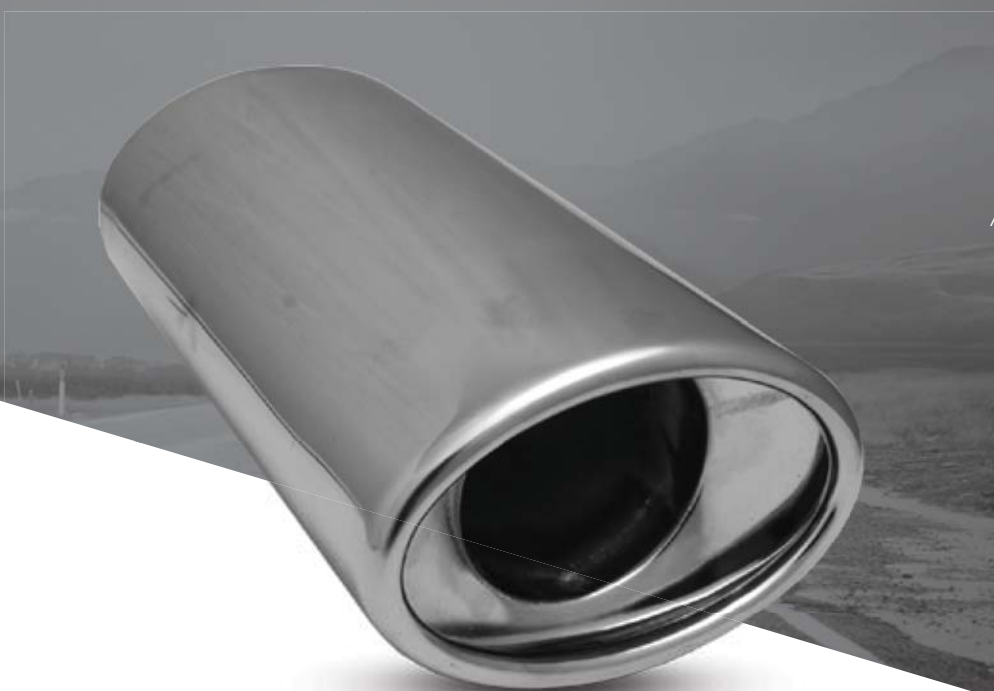

| Referência Reference Référence | Tipo Type Type | D. máx. entrada Max. Fit size D. max. d'entrée | Fixação Fixation Fixation | Miolo Silencer Intérieur | Material Material Matériel |
|--------------------------------------|-----------------------|--|---------------------------------|---|----------------------------------|
| 532.1 | Oval Oval Ovale | 75mm | Solda Welding Soudure | Sem miolo Without silencer Sans intérieur | Inox |
| 532B1-57 | Oval Oval Ovale | 57mm | Solda Welding Soudure | Com miolo With silencer Avec intérieur | Inox |

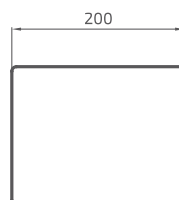
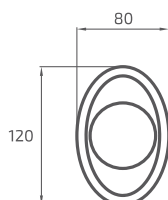

PONTEIRA OVAL
OVAL TRIM
EMBOUT OVALE

533



Saída de escape
Exhaust exit
Sortie d'échappement



Sem miolo
Without silencer
Sans Intérieur



Solda
Welding
Soudure



Diâmetro máximo entrada
Maximum fit size
Diamètre maximum d'entrée



| Referência Reference Référence | Tipo Type Type | D. máx. entrada Max. fit size D. max. d'entrée | Fixação Fixation Fixation | Miolo Silencer Intérieur | Material Material Matériel |
|--------------------------------------|-----------------------|--|---------------------------------|---|----------------------------------|
| 533.1 | Oval Oval Ovale | 57mm | Solda Welding Soudure | Sem miolo Without silencer Sans intérieur | Inox |

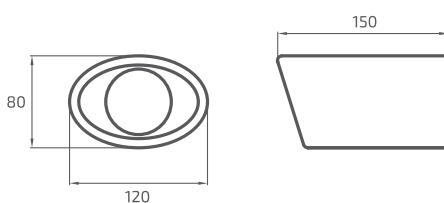

PONTEIRA OVAL
OVAL TRIM
EMBOU OVALE

534



Saída de escape
Exhaust exit
Sortie d'échappement



Sem miolo
Without silencer
Sans Intérieur



Solda
Welding
Soudure



Diâmetro máximo entrada
Maximum Fit size
Diamètre maximum d'entrée

| Referência Reference Référence | Tipo Type Type | D. máx. entrada Max. Fit size D. max. d'entrée | Fixação Fixation Fixation | Miolo Silencer Intérieur | Material Material Matériel |
|--------------------------------------|-----------------------|--|---------------------------------|---|----------------------------------|
| 534.1-60 | Oval Oval Ovale | 60mm | Solda Welding Soudure | Sem miolo Without silencer Sans intérieur | Inox |

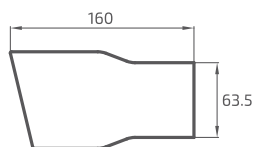
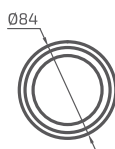

PONTEIRA OVAL
OVAL TRIM
EMBOUT OVALE

535



Saída de escape
Exhaust exit
Sortie d'échappement



Com miolo
With silencer
Avec intérieur



Solda
Welding
Soudure



Diâmetro máximo entrada
Maximum fit size
Diamètre maximum d'entrée



| Referência Reference Référence | Tipo Type Type | D. máx. entrada Max. fit size D. max. d'entrée | Fixação Fixation Fixation | Miolo Silencer Intérieur | Material Material Matériel |
|--------------------------------------|-----------------------|--|---------------------------------|--|----------------------------------|
| 535B1-57 | Oval Oval Ovale | 57mm | Solda Welding Soudure | Com miolo With silencer Avec intérieur | Inox |

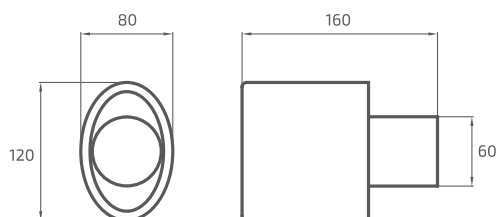

PONTEIRA DTM
DTM TRIM
EMBOUT DTM

537



Saída de escape
Exhaust exit
Sortie d'échappement



Sem miolo
Without silencer
Sans Intérieur



Solda
Welding
Soudure



Diâmetro máximo entrada
Maximum Fit size
Diamètre maximum d'entrée



| Referência Reference Référence | Tipo Type Type | D. máx. entrada Max. Fit size D. max. d'entrée | Fixação Fixation Fixation | Miolo Silencer Intérieur | Material Material Matériel |
|--------------------------------------|----------------------|--|---------------------------------|---|----------------------------------|
| 537.1 | DTM | 73mm | Solda Welding Soudure | Sem miolo Without silencer Sans intérieur | Inox |

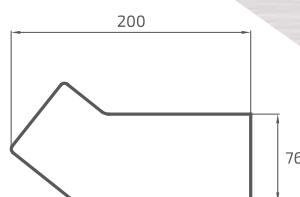
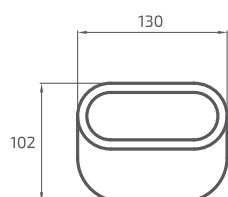

PONTEIRA REDONDA
 ROUND TRIM
 EMBOUT ROND

541
 542
 543
 544 **540**



Saída de escape
 Exhaust exit
 Sortie d'échappement



Sem miolo
 Without silencer
 Sans intérieur



Parafuso
 Screw
 Vis



Min.



Máx.

Diâmetro entrada
 Fit size
 Diamètre d'entrée



| Referência Reference Référence | Tipo Type Type | D. entrada Fit size D. d'entrée | Fixação Fixation Fixation | Miolo Silencer Intérieur | Material Material Matériel |
|--------------------------------------|--------------------------|---|---------------------------------|---|----------------------------------|
| 540.2-37 | Redonda Round Rond | 35  37 | Parafuso Screw Vis | Sem miolo Without silencer Sans intérieur | Inox |
| 541.2-40 | Redonda Round Rond | 38  40 | Parafuso Screw Vis | Sem miolo Without silencer Sans intérieur | Inox |
| 542.2-42 | Redonda Round Rond | 41  42 | Parafuso Screw Vis | Sem miolo Without silencer Sans intérieur | Inox |
| 543.2-45 | Redonda Round Rond | 43  45 | Parafuso Screw Vis | Sem miolo Without silencer Sans intérieur | Inox |
| 544.2-50 | Redonda Round Rond | 46  50 | Parafuso Screw Vis | Sem miolo Without silencer Sans intérieur | Inox |

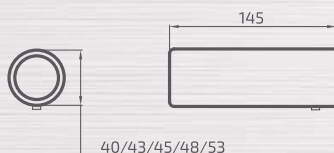

PONTEIRA OVAL
OVAL TRIM
EMBOUT OVALE

547



Saída de escape
Exhaust exit
Sortie d'échappement



Sem miolo
Without silencer
Sans Intérieur



Solda
Welding
Soudure



Diâmetro máximo entrada
Maximum Fit size
Diamètre maximum d'entrée

| Referência Reference Référence | Tipo Type Type | D. máx. entrada Max. Fit size D. max. d'entrée | Fixação Fixation Fixation | Miolo Silencer Intérieur | Material Material Matériel |
|--------------------------------------|-----------------------|--|---------------------------------|---|----------------------------------|
| 547.1-57 | Oval Oval Ovale | 57mm | Solda Welding Soudure | Sem miolo Without silencer Sans intérieur | Inox |

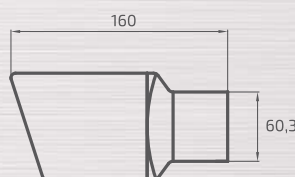
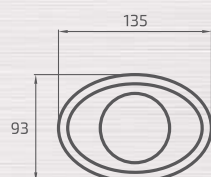

PONTEIRA REDONDA
 ROUND TRIM
 EMBOUT ROND

552
 553 **550**



Saída de escape
 Exhaust exit
 Sortie d'échappement



Sem miolo
 Without silencer
 Sans intérieur



Parafuso
 Screw
 Vis



Min.



Máx.

Diâmetro entrada
 Fit size
 Diamètre d'entrée



| Referência Reference Référence | Tipo Type Type | D. entrada Fit size D. d'entrée | Fixação Fixation Fixation | Miolo Silencer Intérieur | Material Material Matériel |
|--------------------------------------|--------------------------|---------------------------------------|---------------------------------|---|----------------------------------|
| 550.2-40 | Redonda Round Rond | 34 40 | Parafuso Screw Vis | Sem miolo Without silencer Sans intérieur | Inox |
| 552.2-53 | Redonda Round Rond | 47 53 | Parafuso Screw Vis | Sem miolo Without silencer Sans intérieur | Inox |
| 553.2-66 | Redonda Round Rond | 60 66 | Parafuso Screw Vis | Sem miolo Without silencer Sans intérieur | Inox |

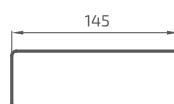
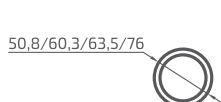

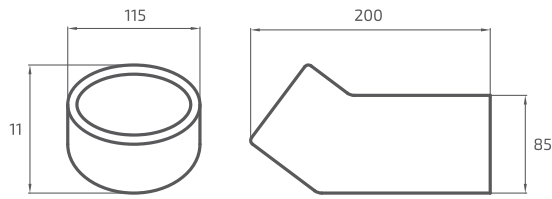

| Referência Reference Référence | Tipo Type Type | D. máx. entrada Max. Fit size D. max. d'entrée | Fixação Fixation Fixation | Miolo Silencer Intérieur | Material Material Matériel |
|--------------------------------------|----------------------|--|---------------------------------|---|----------------------------------|
| 554.1 | DTM | 80mm | Solda Welding Soudure | Sem miolo Without silencer Sans intérieur | Inox |



Saída de escape
Exhaust exit
Sortie d'échappement



Sem miolo
Without silencer
Sans Intérieur



Solda
Welding
Soudure



Diâmetro máximo entrada
Maximum Fit size
Diamètre maximum d'entrée

554

PONTEIRA DTM
DTM TRIM
EMBOUIT DTM

PONTEIRA OVAL
 OVAL TRIM
 EMBOUT OVALE

558

PAR
 SET
 PAIRE



Saída de escape
 Exhaust exit
 Sortie d'échappement



Sem miolo
 Without silencer
 Sans intérieur



Solda
 Welding
 Soudure



Diâmetro máximo entrada
 Maximum Fit size
 Diamètre maximum d'entrée



DIREITA
 RIGHT
 DROIT



ESQUERDA
 LEFT
 GAUCHE

| Referência Reference Référence | Tipo Type Type | D. máx. entrada Max. Fit size D. max. d'entrée | Fixação Fixation Fixation | Miolo Silencer Intérieur | Material Material Matériel |
|--------------------------------------|-----------------------|--|---------------------------------|---|----------------------------------|
| 558.1-57 set | Oval Oval Ovale | 57mm | Solda Welding Soudure | Sem miolo Without silencer Sans intérieur | Inox |

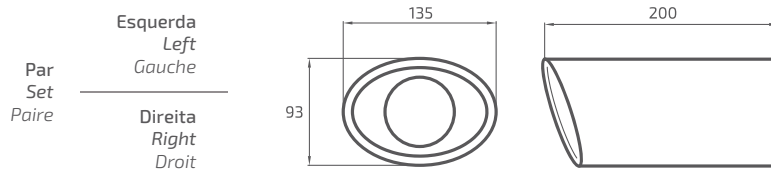

PONTEIRA RETANGULAR
RECTANGULAR TRIM
EMBOUT RECTANGULAIRE

560



Saída de escape
Exhaust exit
Sortie d'échappement



Com miolo
With silencer
Avec Intérieur



Parafuso
Screw
Vis



Min.



Máx.

Diâmetro entrada
Fit size
Diamètre d'entrée

| Referência Reference Référence | Tipo Type Type | D. entrada Fit size D. d'entrée | Fixação Fixation Fixation | Miolo Silencer Intérieur | Material Material Matériel |
|--------------------------------------|--|---------------------------------------|---------------------------------|--|----------------------------------|
| 560B2-58 | Retangular Rectangular Rectangulaire | 58mm | Parafuso Screw Vis | Com miolo With silencer Avec intérieur | Inox |

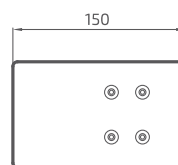
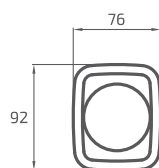

PONTEIRA RETANGULAR
RECTANGULAR TRIM
EMBOUT RECTANGULAIRE

561



Saída de escape
Exhaust exit
Sortie d'échappement



Com miolo
With silencer
Avec intérieur



Parafuso
Screw
Vis



Min.



Máx.

Diâmetro entrada
Fit size
Diamètre d'entrée



| Referência Reference Référence | Tipo Type Type | D. entrada Fit size D. d'entrée | Fixação Fixation Fixation | Miolo Silencer Intérieur | Material Material Matériel |
|--------------------------------------|--|---------------------------------------|---------------------------------|--|----------------------------------|
| 561B2-48 | Retangular Rectangular Rectangulaire | 48mm | Parafuso Screw Vis | Com miolo With silencer Avec intérieur | Inox |

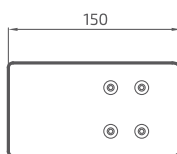
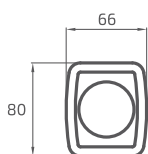

PONTEIRA REDONDA
 ROUND TRIM
 EMBOUT ROND

562



Saída de escape
 Exhaust exit
 Sortie d'échappement



Com miolo
 With silencer
 Avec Intérieur



Parafuso
 Screw
 Vis



Min. Máx.

Diâmetro entrada
 Fit size
 Diamètre d'entrée

| Referência Reference Référence | Tipo Type Type | D. entrada Fit size D. d'entrée | Fixação Fixation Fixation | Miolo Silencer Intérieur | Material Material Matériel |
|--------------------------------------|--------------------------|---------------------------------------|---------------------------------|--|----------------------------------|
| 562B2-48 | Redonda Round Rond | 48mm | Parafuso Screw Vis | Com miolo With silencer Avec intérieur | Inox |
| 562B2-58 | Redonda Round Rond | 58mm | Parafuso Screw Vis | Com miolo With silencer Avec intérieur | Inox |

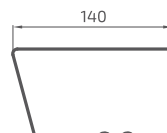
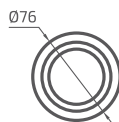

PONTEIRA DUPLA
DOUBLE TRIM
D'ÉCHAPPEMENT DOUBLE

563



Saída de escape
Exhaust exit
Sortie d'échappement



Sem miolo
Without silencer
Sans intérieur



Solda
Welding
Soudure



Diâmetro máximo entrada
Maximum fit size
Diamètre maximum d'entrée



| Referência Reference Référence | Tipo Type Type | D. máx. entrada Max. fit size D. max. d'entrée | Fixação Fixation Fixation | Miolo Silencer Intérieur | Material Material Matériel |
|--------------------------------------|----------------------|--|---------------------------------|--------------------------------|----------------------------------|
|--------------------------------------|----------------------|--|---------------------------------|--------------------------------|----------------------------------|

| | | | | | |
|----------|---------------------------|------|-----------------------------|---|------|
| 563.1-60 | Dupla Double Double | 60mm | Solda Welding Soudure | Sem miolo Without silencer Sans intérieur | Inox |
|----------|---------------------------|------|-----------------------------|---|------|

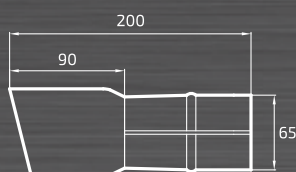
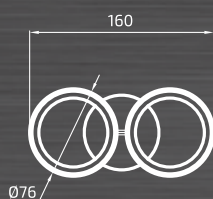

PONTEIRA REDONDA
ROUND TRIM
EMBOUT ROND

574



Saída de escape
Exhaust exit
Sortie d'échappement



Miolo perfurado
Perforated silencer
Intérieur perforé



Com miolo
With silencer
Avec intérieur



Solda
Welding
Soudure



Diâmetro máximo entrada
Maximum Fit size
Diamètre maximum d'entrée



| Referência Reference Référence | Tipo Type Type | D. máx. entrada Max. Fit size D. max. d'entrée | Fixação Fixation Fixation | Miolo Silencer Intérieur | Material Material Matériel |
|--------------------------------------|--------------------------|--|---------------------------------|--|----------------------------------|
| 574A1-47 | Redonda Round Rond | 47mm | Solda Welding Soudure | Perfurado Perforated Perforé | Inox |
| 574B1-47 | Redonda Round Rond | 47mm | Solda Welding Soudure | Com miolo With silencer Avec intérieur | Inox |

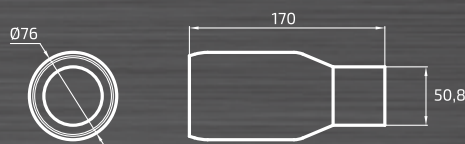

PONTEIRA REDONDA
 ROUND TRIM
 EMBOUT ROND

575



Saída de escape
 Exhaust exit
 Sortie d'échappement



Com miolo
 With silencer
 Avec intérieur



Miolo perfurado
 Perforated silencer
 Intérieur perforé



Solda
 Welding
 Soudure



Diâmetro máximo entrada
 Maximum fit size
 Diamètre maximum d'entrée



| Referência Reference Référence | Tipo Type Type | D. máx. entrada Max. fit size D. max. d'entrée | Fixação Fixation Fixation | Miolo Silencer Intérieur | Material Material Matériel |
|--------------------------------------|--------------------------|--|---------------------------------|--|----------------------------------|
| 575A1-47 | Redonda Round Rond | 47mm | Solda Welding Soudure | Perfurado Perforated Perforé | Inox |
| 575B1-47 | Redonda Round Rond | 47mm | Solda Welding Soudure | Com miolo With silencer Avec intérieur | Inox |

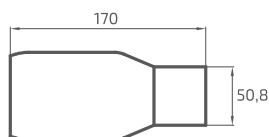
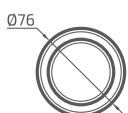

PONTEIRA REDONDA
 ROUND TRIM
 EMBOUT ROND

576



Saída de escape
 Exhaust exit
 Sortie d'échappement



Miolo perfurado
 Perforated silencer
 Intérieur perforé



Solda
 Welding
 Soudure



Diâmetro máximo entrada
 Maximum Fit size
 Diamètre maximum d'entrée

| Referência Reference Référence | Tipo Type Type | D. máx. entrada Max. Fit size D. max. d'entrée | Fixação Fixation Fixation | Miolo Silencer Intérieur | Material Material Matériel |
|--------------------------------------|--------------------------|--|---------------------------------|------------------------------------|----------------------------------|
| 576A1-60 | Redonda Round Rond | 60mm | Solda Welding Soudure | Perfurado Perforated Perforé | Inox |

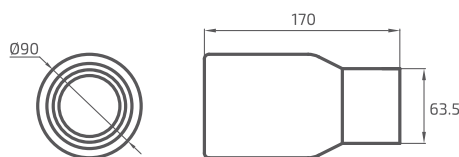

PONTEIRA REDONDA
ROUND TRIM
EMBOUT ROND

577



Saída de escape
Exhaust exit
Sortie d'échappement



Miolo perfurado
Perforated silencer
Intérieur perforé

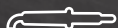

Solda
Welding
Soudure



Diâmetro máximo entrada
Maximum Fit size
Diamètre maximum d'entrée



| Referência Reference Référence | Tipo Type Type | D. máx. entrada Max. Fit size D. max. d'entrée | Fixação Fixation Fixation | Miolo Silencer Intérieur | Material Material Matériel |
|--------------------------------------|--------------------------|--|---------------------------------|------------------------------------|----------------------------------|
| 577A1-60 | Redonda Round Rond | 60mm | Solda Welding Soudure | Perfurado Perforated Perforé | Inox |

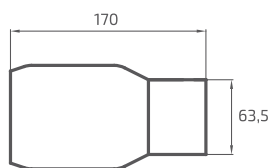
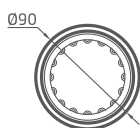

PONTEIRA REDONDA
ROUND TRIM
EMBOUT ROND

578



Saída de escape
Exhaust exit
Sortie d'échappement



Com miolo
With silencer
Avec intérieur



Solda
Welding
Soudure



Diâmetro máximo entrada
Maximum Fit size
Diamètre maximum d'entrée



| Referência Reference Référence | Tipo Type Type | D. máx. entrada Max. Fit size D. max. d'entrée | Fixação Fixation Fixation | Miolo Silencer Intérieur | Material Material Matériel |
|--------------------------------------|--------------------------|--|---------------------------------|--|----------------------------------|
| 578B1-60 | Redonda Round Rond | 60mm | Solda Welding Soudure | Com miolo With silencer Avec intérieur | Inox |

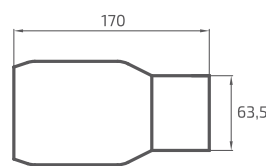
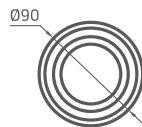

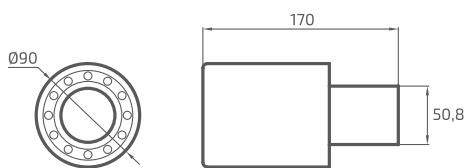

| Referência Reference Référence | Tipo Type Type | D. máx. entrada Max. Fit size D. max. d'entrée | Fixação Fixation Fixation | Miolo Silencer Intérieur | Material Material Matériel |
|--------------------------------------|--------------------------|--|---------------------------------|--|----------------------------------|
| 579B1-47 | Redonda Round Rond | 47mm | Solda Welding Soudure | Com miolo With silencer Avec intérieur | Inox |



Saída de escape
Exhaust exit
Sortie d'échappement



Com miolo
With silencer
Avec intérieur

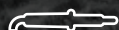

Solda
Welding
Soudure



Diâmetro máximo entrada
Maximum Fit size
Diamètre maximum d'entrée



579

PONTEIRA REDONDA
ROUND TRIM
EMBOUT ROND

PONTEIRA REDONDA
ROUND TRIM
EMBOUT ROND

580



Saída de escape
Exhaust exit
Sortie d'échappement



Com miolo
With silencer
Avec intérieur



Solda
Welding
Soudure



Diâmetro máximo entrada
Maximum Fit size
Diamètre maximum d'entrée



| Referência Reference Référence | Tipo Type Type | D. máx. entrada Max. Fit size D. max. d'entrée | Fixação Fixation Fixation | Miolo Silencer Intérieur | Material Material Matériel |
|--------------------------------------|--------------------------|--|---------------------------------|--|----------------------------------|
| 580B1-47 | Redonda Round Rond | 47mm | Solda Welding Soudure | Com miolo With silencer Avec intérieur | Inox |

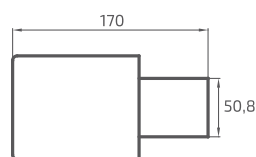
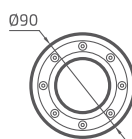

PONTEIRA REDONDA
 ROUND TRIM
 EMBOUT ROND

581



Saída de escape
 Exhaust exit
 Sortie d'échappement



Com miolo
 With silencer
 Avec intérieur



Solda
 Welding
 Soudure



Diâmetro máximo entrada
 Maximum fit size
 Diamètre maximum d'entrée



| Referência Reference Référence | Tipo Type Type | D. máx. entrada Max. fit size D. max. d'entrée | Fixação Fixation Fixation | Miolo Silencer Intérieur | Material Material Matériel |
|--------------------------------------|--------------------------|--|---------------------------------|--|----------------------------------|
| 581B1-60 | Redonda Round Rond | 60mm | Solda Welding Soudure | Com miolo With silencer Avec intérieur | Inox |

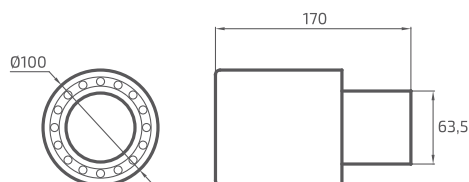

PONTEIRA REDONDA
ROUND TRIM
EMBOUT ROND

582



Saída de escape
Exhaust exit
Sortie d'échappement



Com miolo
With silencer
Avec intérieur



Solda
Welding
Soudure



Diâmetro máximo entrada
Maximum fit size
Diamètre maximum d'entrée

| Referência Reference Référence | Tipo Type Type | D. máx. entrada Max. Fit size D. max. d'entrée | Fixação Fixation Fixation | Miolo Silencer Intérieur | Material Material Matériel |
|--------------------------------------|--------------------------|--|---------------------------------|--|----------------------------------|
| 582B1-60 | Redonda Round Rond | 60mm | Solda Welding Soudure | Com miolo With silencer Avec intérieur | Inox |

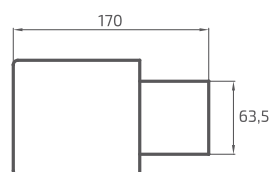
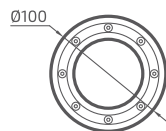

PONTEIRA REDONDA
ROUND TRIM
EMBOUT ROND

584



Saída de escape
Exhaust exit
Sortie d'échappement



Com miolo
With silencer
Avec intérieur



Solda
Welding
Soudure



Diâmetro máximo entrada
Maximum Fit size
Diamètre maximum d'entrée



| Referência Reference Référence | Tipo Type Type | D. máx. entrada Max. Fit size D. max. d'entrée | Fixação Fixation Fixation | Miolo Silencer Intérieur | Material Material Matériel |
|--------------------------------------|--------------------------|--|---------------------------------|--|----------------------------------|
| 584B1-85 | Redonda Round Rond | 85mm | Solda Welding Soudure | Com miolo With silencer Avec intérieur | Inox |

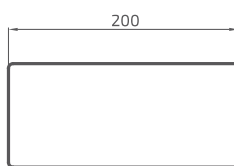
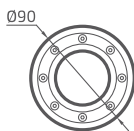

PONTEIRA DUPLA
DOUBLE TRIM
D'ÉCHAPPEMENT DOUBLE

PAR
SET
PAIRE

586



DIREITA
RIGHT
DROIT



Saída de escape
Exhaust exit
Sortie d'échappement



Sem miolo
Without silencer
Sans intérieur



Solda
Welding
Soudure



Diâmetro máximo entrada
Maximum fit size
Diamètre maximum d'entrée



ESQUERDA
LEFT
GAUCHE

| Referência Reference Référence | Tipo Type Type | D. máx. entrada Max. Fit size D. max. d'entrée | Fixação Fixation Fixation | Miolo Silencer Intérieur | Material Material Matériel |
|--------------------------------------|---------------------------|--|---------------------------------|---|----------------------------------|
| 586.1-60 set | Dupla Double Double | 60mm | Solda Welding Soudure | Sem miolo Without silencer Sans intérieur | Inox |

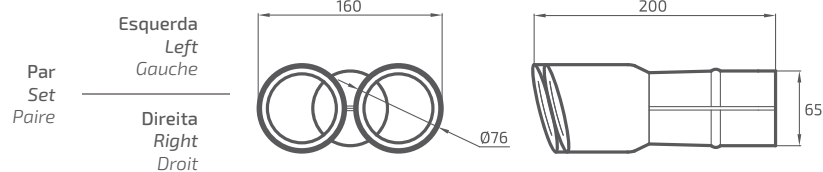

PONTEIRA DUPLA
DOUBLE TRIM
D'ÉCHAPPEMENT DOUBLE

587

PAR
SET
PAIRE



Saída de escape
Exhaust exit
Sortie d'échappement



Sem miolo
Without silencer
Sans intérieur



Solda
Welding
Soudure



Diâmetro máximo entrada
Maximum fit size
Diamètre maximum d'entrée



| Referência Reference Référence | Tipo Type Type | D. máx. entrada Max. fit size D. max. d'entrée | Fixação Fixation Fixation | Miolo Silencer Intérieur | Material Material Matériel |
|--------------------------------------|---------------------------|--|---------------------------------|---|----------------------------------|
| 587.1-60 set | Dupla Double Double | 60mm | Solda Welding Soudure | Sem miolo Without silencer Sans intérieur | Inox |

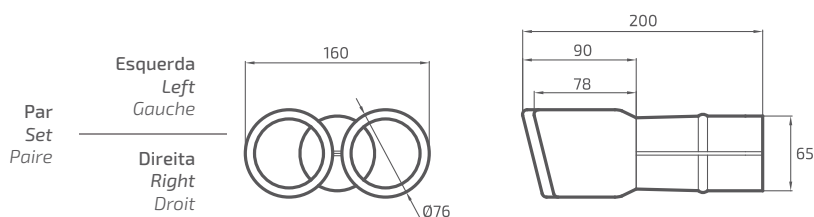

PONTEIRA RETANGULAR
RECTANGULAR TRIM
EMBOUT RECTANGULAIRE

588



Saída de escape
Exhaust exit
Sortie d'échappement



Com miolo
With silencer
Avec intérieur



Solda
Welding
Soudure



Díâmetro máximo entrada
Maximum fit size
Diamètre maximum d'entrée

| Referência Reference Référence | Tipo Type Type | D. máx. entrada Max. fit size D. max. d'entrée | Fixação Fixation Fixation | Miolo Silencer Intérieur | Material Material Matériel |
|--------------------------------------|--|--|---------------------------------|--|----------------------------------|
| 588B1-60 | Retangular Rectangular Rectangulaire | 60mm | Solda Welding Soudure | Com miolo With silencer Avec intérieur | Inox |

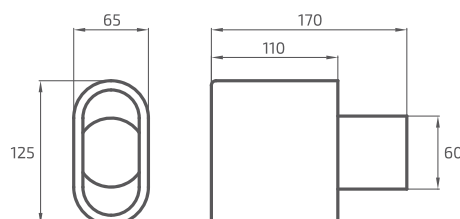

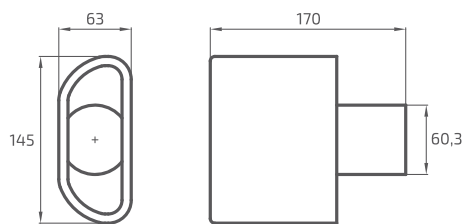

| Referência Reference Référence | Tipo Type Type | D. máx. entrada Max. Fit size D. max. d'entrée | Fixação Fixation Fixation | Miolo Silencer Intérieur | Material Material Matériel |
|--------------------------------------|--|--|---------------------------------|---|----------------------------------|
| 589.1-57 | Retangular Rectangular Rectangulaire | 57mm | Solda Welding Soudure | Sem miolo Without silencer Sans intérieur | Inox |



Saída de escape
Exhaust outlet
Sortie d'échappement



Sem miolo
Cored
Évidées

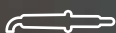

Solda
Solder
Soudure



Abertura
Aperture
Ouverture



589

PONTEIRA RETANGULAR
RECTANGULAR TRIM
EMBOUOT RECTANGULAIRE

PONTEIRA DIESEL
DIESEL TRIM
EMBOU D'ÉCHAPPEMENT DIESEL

591



Saída de escape
Exhaust exit
Sortie d'échappement



Sem miolo
Without silencer
Sans intérieur



Solda
Welding
Soudure



Diâmetro máximo entrada
Maximum fit size
Diamètre maximum d'entrée

| Referência Reference Référence | Tipo Type Type | D. máx. entrada Max. fit size D. max. d'entrée | Fixação Fixation Fixation | Miolo Silencer Intérieur | Material Material Matériel |
|--------------------------------------|----------------------|--|---------------------------------|---|----------------------------------|
| 591.1x200 | Diesel | 60mm | Solda Welding Soudure | Sem miolo Without silencer Sans intérieur | Inox |

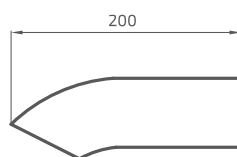

PONTEIRA DTM
DTM TRIM
EMBOUIT DTM

592



Saída de escape
Exhaust exit
Sortie d'échappement



S/ miolo
Without silencer
Sans intérieur



Solda
Welding
Soudure



Diâmetro máximo entrada
Maximum fit size
Diamètre maximum d'entrée



| Referência Reference Référence | Tipo Type Type | D. máx. entrada Max. Fit size D. max. d'entrée | Fixação Fixation Fixation | Miolo Silencer Intérieur | Material Material Matériel |
|--------------------------------------|----------------------|--|---------------------------------|---|----------------------------------|
| 592.1x170 | DTM | 60mm | Solda Welding Soudure | Sem miolo Without silencer Sans intérieur | Inox |
| 592.1x200 | DTM | 60mm | Solda Welding Soudure | Sem miolo Without silencer Sans intérieur | Inox |

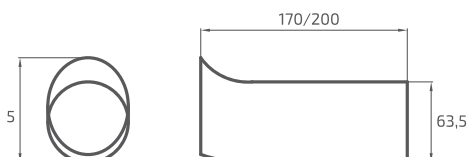

PONTEIRA DIESEL
DIESEL TRIM
EMBOUOT D'ECHAPPEMENT DIESEL

593



Saída de escape
Exhaust exit
Sortie d'échappement



Sem miolo
Without silencer
Sans intérieur



Solda
Welding
Soudure



Diâmetro máximo entrada
Maximum fit size
Diamètre maximum d'entrée

| Referência Reference Référence | Tipo Type Type | D. máx. entrada Max. fit size D. max. d'entrée | Fixação Fixation Fixation | Miolo Silencer Intérieur | Material Material Matériel |
|--------------------------------------|----------------------|--|---------------------------------|---|----------------------------------|
| 593.1x200 | Diesel | 73mm | Solda Welding Soudure | Sem miolo Without silencer Sans intérieur | Inox |

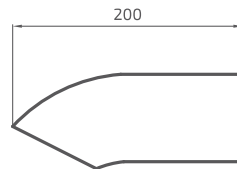
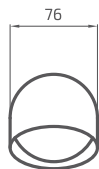

PONTEIRA DUPLA
DOUBLE TRIM
D'ÉCHAPPEMENT DOUBLE

596



Saída de escape
Exhaust exit
Sortie d'échappement



Sem miolo
Without silencer
Sans intérieur



Solda
Welding
Soudure



Diâmetro máximo entrada
Maximum fit size
Diamètre maximum d'entrée



| Referência Reference Référence | Tipo Type Type | D. máx. entrada Max. fit size D. max. d'entrée | Fixação Fixation Fixation | Miolo Silencer Intérieur | Material Material Matériel |
|--------------------------------------|----------------------|--|---------------------------------|--------------------------------|----------------------------------|
|--------------------------------------|----------------------|--|---------------------------------|--------------------------------|----------------------------------|

| | | | | | |
|----------|---------------------------|------|-----------------------------|---|------|
| 596.1-60 | Dupla Double Double | 60mm | Solda Welding Soudure | Sem miolo Without silencer Sans intérieur | Inox |
|----------|---------------------------|------|-----------------------------|---|------|

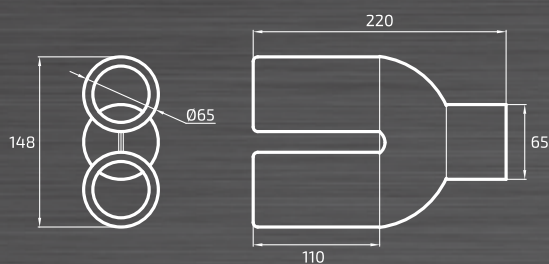

PONTEIRA DUPLA
DOUBLE TRIM
D'ÉCHAPPEMENT DOUBLE

597



Saída de escape
Exhaust exit
Sortie d'échappement



Sem miolo
Without silencer
Sans intérieur



Solda
Welding
Soudure



Diâmetro máximo entrada
Maximum Fit size
Diamètre maximum d'entrée

| Referência Reference Référence | Tipo Type Type | D. máx. entrada Max. Fit size D. max. d'entrée | Fixação Fixation Fixation | Miolo Silencer Intérieur | Material Material Matériel |
|--------------------------------------|---------------------------|--|---------------------------------|---|----------------------------------|
| 597.1-60 | Dupla Double Double | 60mm | Solda Welding Soudure | Sem miolo Without silencer Sans intérieur | Inox |

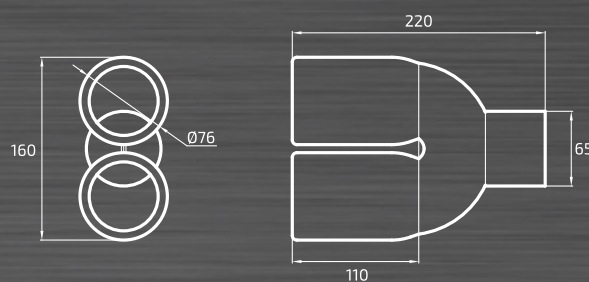

PONTEIRA DUPLA
DOUBLE TRIM
D'ÉCHAPPEMENT DOUBLE

598



Saída de escape
Exhaust exit
Sortie d'échappement



Sem miolo
Without silencer
Sans intérieur



Com miolo
With silencer
Avec intérieur

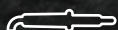

Solda
Welding
Soudure



Diâmetro máximo entrada
Maximum fit size
Diamètre maximum d'entrée



| Referência Reference Référence | Tipo Type Type | D. máx. entrada Max. fit size D. max. d'entrée | Fixação Fixation Fixation | Miolo Silencer Intérieur | Material Material Matériel |
|--------------------------------------|---------------------------|--|---------------------------------|---|----------------------------------|
| 598.1-60 | Dupla Double Double | 60mm | Solda Welding Soudure | Sem miolo Without silencer Sans intérieur | Inox |
| 598B1-60 | Dupla Double Double | 60mm | Solda Welding Soudure | Com miolo With silencer Avec intérieur | Inox |

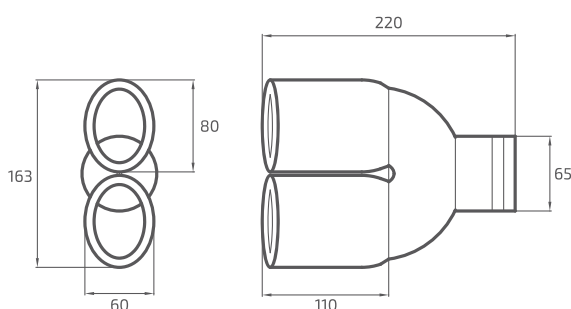

PONTEIRA DUPLA
DOUBLE TRIM
D'ÉCHAPPEMENT DOUBLE

599



Saída de escape
Exhaust exit
Sortie d'échappement



Sem miolo
Without silencer
Sans intérieur

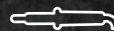

Solda
Welding
Soudure



Diâmetro máximo entrada
Maximum fit size
Diamètre maximum d'entrée



| Referência Reference Référence | Tipo Type Type | D. máx. entrada Max. fit size D. max. d'entrée | Fixação Fixation Fixation | Miolo Silencer Intérieur | Material Material Matériel |
|--------------------------------------|---------------------------|--|---------------------------------|---|----------------------------------|
| 599.1-60 | Dupla Double Double | 60mm | Solda Welding Soudure | Sem miolo Without silencer Sans intérieur | Inox |

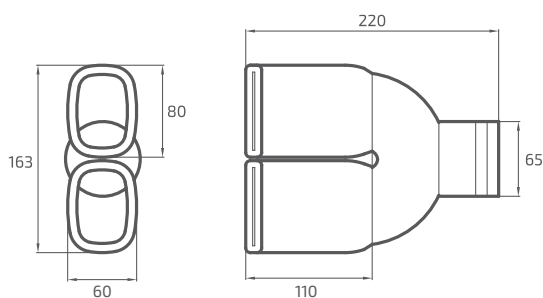

PONTEIRA DUPLA
DOUBLE TRIM
D'ÉCHAPPEMENT DOUBLE

600



Saída de escape
Exhaust exit
Sortie d'échappement



Sem miolo
Without silencer
Sans intérieur



Solda
Welding
Soudure



Diâmetro máximo entrada
Maximum fit size
Diamètre maximum d'entrée



| Referência Reference Référence | Tipo Type Type | D. máx. entrada Max. fit size D. max. d'entrée | Fixação Fixation Fixation | Miolo Silencer Intérieur | Material Material Matériel |
|--------------------------------------|---------------------------|--|---------------------------------|---|----------------------------------|
| 600.1-60 | Dupla Double Double | 60mm | Solda Welding Soudure | Sem miolo Without silencer Sans intérieur | Inox |

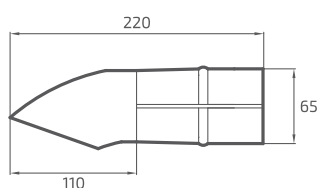
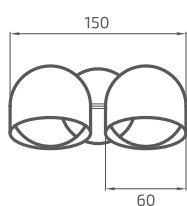

PONTEIRA DUPLA
DOUBLE TRIM
D'ÉCHAPPEMENT DOUBLE

601



Saída de escape
Exhaust exit
Sortie d'échappement



Sem miolo
Without silencer
Sans intérieur



Solda
Welding
Soudure



Diâmetro máximo entrada
Maximum Fit size
Diamètre maximum d'entrée



| Referência Reference Référence | Tipo Type Type | D. máx. entrada Max. Fit size D. max. d'entrée | Fixação Fixation Fixation | Miolo Silencer Intérieur | Material Material Matériel |
|--------------------------------------|---------------------------|--|---------------------------------|---|----------------------------------|
| 601.1-60 | Dupla Double Double | 60mm | Solda Welding Soudure | Sem miolo Without silencer Sans intérieur | Inox |

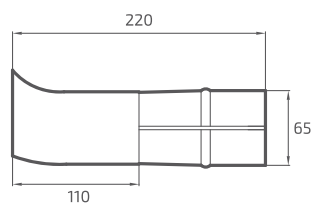
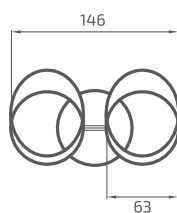

PONTEIRA DUPLA
DOUBLE TRIM
D'ÉCHAPPEMENT DOUBLE

657



Saída de escape
Exhaust exit
Sortie d'échappement



Sem miolo
Without silencer
Sans intérieur



Com miolo
With silencer
Avec intérieur



Solda
Welding
Soudure



Diâmetro máximo entrada
Maximum fit size
Diamètre maximum d'entrée



| Referência Reference Référence | Tipo Type Type | D. máx. entrada Max. fit size D. max. d'entrée | Fixação Fixation Fixation | Miolo Silencer Intérieur | Material Material Matériel |
|--------------------------------------|---------------------------|--|---------------------------------|---|----------------------------------|
| 657.1-60 | Dupla Double Double | 60mm | Solda Welding Soudure | Sem miolo Without silencer Sans intérieur | Inox |
| 657B1-60 | Dupla Double Double | 60mm | Solda Welding Soudure | Com miolo With silencer Avec intérieur | Inox |

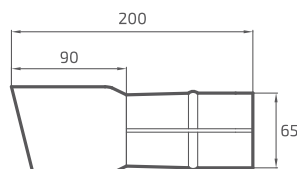
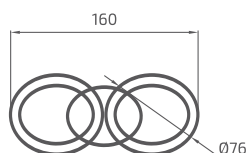

PONTEIRA DUPLA
DOUBLE TRIM
D'ÉCHAPPEMENT DOUBLE

PAR
SET
PAIRE

657



DIREITA
RIGHT
DROIT



ESQUERDA
LEFT
GAUCHE



Saída de escape
Exhaust exit
Sortie d'échappement



Com miolo
With silencer
Avec intérieur



Solda
Welding
Soudure



Diâmetro máximo entrada
Maximum fit size
Diamètre maximum d'entrée

| Referência Reference Référence | Tipo Type Type | D. máx. entrada Max. Fit size D. max. d'entrée | Fixação Fixation Fixation | Miolo Silencer Intérieur | Material Material Matériel |
|--------------------------------------|---------------------------|--|---------------------------------|--|----------------------------------|
| 657B1-60 set | Dupla Double Double | 60mm | Solda Welding Soudure | Com miolo With silencer Avec intérieur | Inox |

Par
Set
Paire

Esquerda
Left
Gauche

Direita
Right
Droit

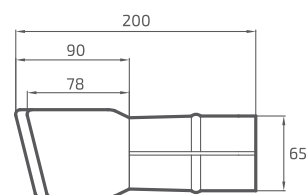
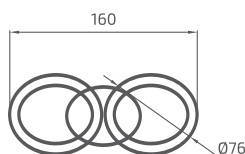

PONTEIRA OVAL
 OVAL TRIM
 EMBOUT OVALE

658

PAR
 SET
 PAIRE



Saída de escape
 Exhaust exit
 Sortie d'échappement



Sem miolo
 Without silencer
 Sans intérieur



Com miolo
 With silencer
 Avec intérieur



Solda
 Welding
 Soudure



Diâmetro máximo entrada
 Maximum fit size
 Diamètre maximum d'entrée



DIREITA
 RIGHT
 DROIT



ESQUERDA
 LEFT
 GAUCHE

| Referência Reference Référence | Tipo Type Type | D. máx. entrada Max. fit size D. max. d'entrée | Fixação Fixation Fixation | Miolo Silencer Intérieur | Material Material Matériel |
|--------------------------------------|-----------------------|--|---------------------------------|---|----------------------------------|
| 658.1-57 set | Oval Oval Ovale | 57mm | Solda Welding Soudure | Sem miolo Without silencer Sans intérieur | Inox |
| 658B1-57 set | Oval Oval Ovale | 57mm | Solda Welding Soudure | Com miolo With silencer Avec intérieur | Inox |

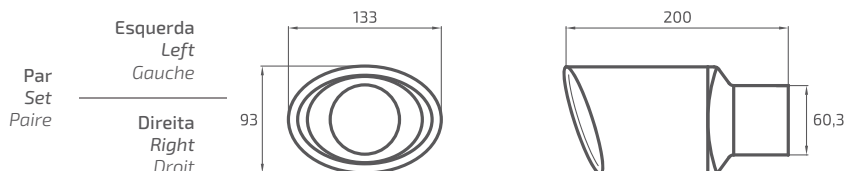

PONTEIRA RETANGULAR
RECTANGULAR TRIM
EMBOUT RECTANGULAIRE

661



Saída de escape
Exhaust exit
Sortie d'échappement



Sem miolo
Without silencer
Sans intérieur



Solda
Welding
Soudure



Diâmetro máximo entrada
Maximum fit size
Diamètre maximum d'entrée

| Referência Reference Référence | Tipo Type Type | D. máx. entrada Max. fit size D. max. d'entrée | Fixação Fixation Fixation | Miolo Silencer Intérieur | Material Material Matériel |
|--------------------------------------|--|--|---------------------------------|---|----------------------------------|
| 661.1 | Retangular Rectangular Rectangulaire | 55mm | Solda Welding Soudure | Sem miolo Without silencer Sans intérieur | Inox |

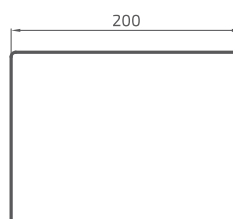
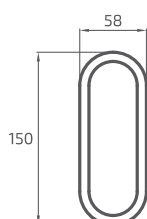

PONTEIRA RETANGULAR
RECTANGULAR TRIM
EMBOUT RECTANGULAIRE

662



Saída de escape
Exhaust exit
Sortie d'échappement



Sem miolo
Without silencer
Sans intérieur



Solda
Welding
Soudure



Diâmetro máximo entrada
Maximum fit size
Diamètre maximum d'entrée



| Referência Reference Référence | Tipo Type Type | D. máx. entrada Max. fit size D. max. d'entrée | Fixação Fixation Fixation | Miolo Silencer Intérieur | Material Material Matériel |
|--------------------------------------|--|--|---------------------------------|---|----------------------------------|
| 662.1-57 | Retangular Rectangular Rectangulaire | 57mm | Solda Welding Soudure | Sem miolo Without silencer Sans intérieur | Inox |

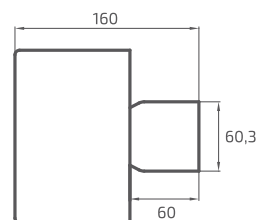
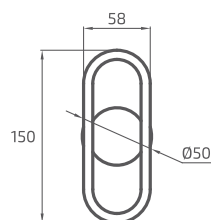

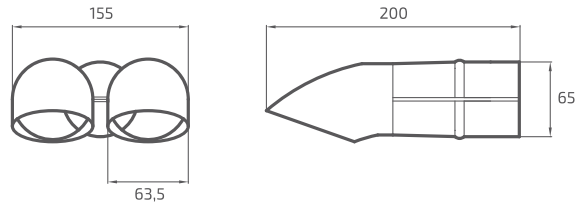

| Referência Reference Référence | Tipo Type Type | D. máx. entrada Max. Fit size D. max. d'entrée | Fixação Fixation Fixation | Miolo Silencer Intérieur | Material Material Matériel |
|--------------------------------------|---------------------------|--|---------------------------------|---|----------------------------------|
| 663.1-60 | Dupla Double Double | 60mm | Solda Welding Soudure | Sem miolo Without silencer Sans intérieur | Inox |



Saída de escape
Exhaust exit
Sortie d'échappement



Sem miolo
Without silencer
Sans intérieur

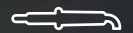

Solda
Welding
Soudure



Diâmetro máximo entrada
Maximum Fit size
Diamètre maximum d'entrée

663

PONTEIRA DUPLA
DOUBLE TRIM
D'ÉCHAPPEMENT DOUBLE

PONTEIRA DUPLA
 DOUBLE TRIM
 D'ÉCHAPPEMENT DOUBLE

664



Saída de escape
 Exhaust exit
 Sortie d'échappement



Sem miolo
 Without silencer
 Sans intérieur



Solda
 Welding
 Soudure



Diâmetro máximo entrada
 Maximum fit size
 Diamètre maximum d'entrée



| Referência Reference Référence | Tipo Type Type | D. máx. entrada Max. fit size D. max. d'entrée | Fixação Fixation Fixation | Miolo Silencer Intérieur | Material Material Matériel |
|--------------------------------------|---------------------------|--|---------------------------------|---|----------------------------------|
| 664.1-60 | Dupla Double Double | 60mm | Solda Welding Soudure | Sem miolo Without silencer Sans intérieur | Inox |

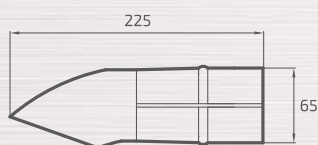
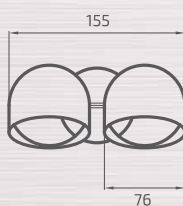

PONTEIRA DIESEL
DIESEL TRIM
EMBOUT D'ÉCHAPPEMENT DIESEL

661



Saída de escape
Exhaust exit
Sortie d'échappement



Sem miolo
Without silencer
Sans intérieur



Solda
Welding
Soudure



Diâmetro máximo entrada
Maximum fit size
Diamètre maximum d'entrée



| Referência Reference Référence | Tipo Type Type | D. máx. entrada Max. fit size D. max. d'entrée | Fixação Fixation Fixation | Miolo Silencer Intérieur | Material Material Matériel |
|--------------------------------------|----------------------|--|---------------------------------|---|----------------------------------|
| 665.1-57 | Diesel | 57mm | Solda Welding Soudure | Sem miolo Without silencer Sans intérieur | Inox |

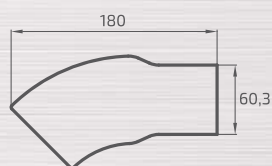

PONTEIRA DUPLA
DOUBLE TRIM
D'ÉCHAPPEMENT DOUBLE

681

PAR
SET
PAIRE



Saída de escape
Exhaust exit
Sortie d'échappement



Com miolo
With silencer
Avec intérieur



Solda
Welding
Soudure



Diâmetro máximo entrada
Maximum fit size
Diamètre maximum d'entrée



ESQUERDA
LEFT
GAUCHE



DIREITA
RIGHT
DROIT

| Referência Reference Référence | Tipo Type Type | D. máx. entrada Max. fit size D. max. d'entrée | Fixação Fixation Fixation | Miolo Silencer Intérieur | Material Material Matériel |
|--------------------------------------|---------------------------|--|---------------------------------|--|----------------------------------|
| 681B1-60 set | Dupla Double Double | 60mm | Solda Welding Soudure | Com miolo With silencer Avec intérieur | Inox |

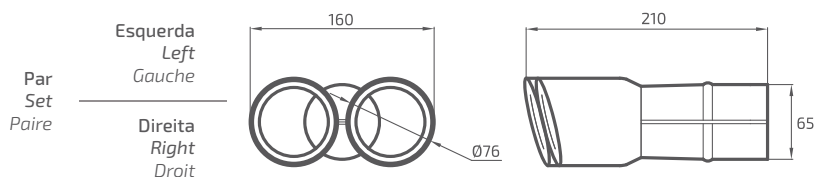

PONTEIRA OVAL
OVAL TRIM
EMBOUT OVALE

682



Saída de escape
Exhaust exit
Sortie d'échappement



Com miolo
With silencer
Avec intérieur

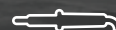

Solda
Welding
Soudure



Diâmetro máximo entrada
Maximum fit size
Diamètre maximum d'entrée



| Referência Reference Référence | Tipo Type Type | D. máx. entrada Max. fit size D. max. d'entrée | Fixação Fixation Fixation | Miolo Silencer Intérieur | Material Material Matériel |
|--------------------------------------|-----------------------|--|---------------------------------|--|----------------------------------|
| 682B1-57 set | Oval Oval Ovale | 57mm | Solda Welding Soudure | Com miolo With silencer Avec intérieur | Inox |

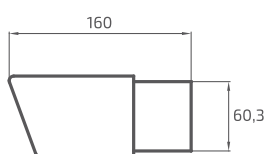
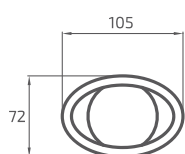

PONTEIRA REDONDA
 ROUND TRIM
 EMBOUT ROND

684



Saída de escape
 Exhaust exit
 Sortie d'échappement



Com miolo
 With silencer
 Avec intérieur



Solda
 Welding
 Soudure



Diâmetro máximo entrada
 Maximum fit size
 Diamètre maximum d'entrée



| Referência Reference Référence | Tipo Type Type | D. máx. entrada Max. fit size D. max. d'entrée | Fixação Fixation Fixation | Miolo Silencer Intérieur | Material Material Matériel |
|--------------------------------------|--------------------------|--|---------------------------------|--|----------------------------------|
| 684B1-40 | Redonda Round Rond | 40mm | Solda Welding Soudure | Com miolo With silencer Avec intérieur | Inox |

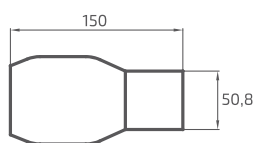
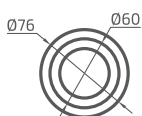

PONTEIRA REDONDA
ROUND TRIM
EMBOUT ROND

685



Saída de escape
Exhaust exit
Sortie d'échappement



Com miolo
With silencer
Avec intérieur



Solda
Welding
Soudure



Diâmetro máximo entrada
Maximum fit size
Diamètre maximum d'entrée



| Referência Reference Référence | Tipo Type Type | D. máx. entrada Max. Fit size D. max. d'entrée | Fixação Fixation Fixation | Miolo Silencer Intérieur | Material Material Matériel |
|--------------------------------------|--------------------------|--|---------------------------------|--|----------------------------------|
| 685B1-57x130 | Redonda Round Rond | 57mm | Solda Welding Soudure | Com miolo With silencer Avec intérieur | Inox |
| 685B1-57x160 | Redonda Round Rond | 57mm | Solda Welding Soudure | Com miolo With silencer Avec intérieur | Inox |

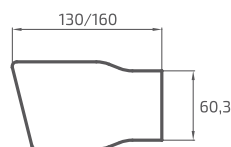
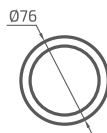

PONTEIRA DUPLA
DOUBLE TRIM
D'ÉCHAPPEMENT DOUBLE

686



Saída de escape
Exhaust exit
Sortie d'échappement



Com miolo
With silencer
Avec intérieur



Solda
Welding
Soudure



Diâmetro máximo entrada
Maximum fit size
Diamètre maximum d'entrée



| Referência <i>Reference</i> <i>Référence</i> | Tipo <i>Type</i> <i>Type</i> | D. máx. entrada <i>Max. fit size</i> <i>D. max. d'entrée</i> | Fixação <i>Fixation</i> <i>Fixation</i> | Miolo <i>Silencer</i> <i>Intérieur</i> | Material <i>Material</i> <i>Matériel</i> |
|--|---|--|---|--|--|
| 686B1-60 | Dupla <i>Double</i> <i>Double</i> | 60mm | Solda <i>Welding</i> <i>Soudure</i> | Com miolo <i>With silencer</i> <i>Avec intérieur</i> | Inox |

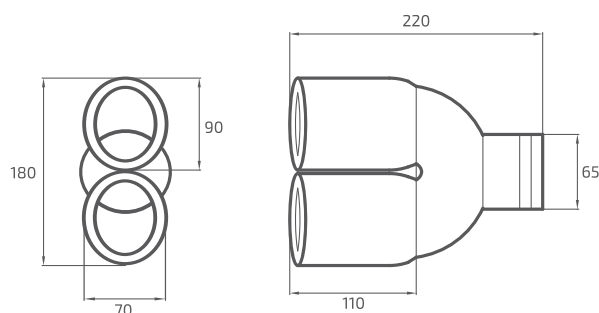



PAVILAUTO
AUTO PARTS & ACCESSORIES

Rua do Casino, nº 95 Lt. 3
4765-063 Bairro
V.N. Famalicão • Portugal

Tlf. (+351) 252 907 210 • 252 981 420
E-mail. info@pavilauto.com

www.pavilauto.com



ON
THE
ROAD